

RetroSound®

Model Two Radio Installation and Owner's Manual



Made for
iPod iPhone

**AM/FM Radio with iPod®/iPhone®, USB MP3/WMA Playback
and InfiniMount Shaft/Bracket System**

The information enclosed in this installation manual is to be used as a guide to assist you during the process of installation. This guide does not cover every installation possibility, vehicle, or every aspect of the installation process.

Retro Manufacturing, LLC, RetroSound®, or its subsidiaries, assume no responsibility for any installation. This manual may be updated from time to time.

Please check our website for the latest updates: www.retrosoundusa.com.

Table of Contents

Licensing.....	2
Welcome!	3
What's in the Box	4
Warnings and Precautions.....	5
Installation Warnings.....	8
Installation Instructions.....	9
Wiring Instructions	13
Using Your Radio (Basic Operation).....	15
Adjusting Sound Properties	20
Sub-Menu System	24
USB Device Instructions.....	30
Bluetooth Instructions.....	32
Troubleshooting	34
Frequently Asked Questions.....	35
Specifications.....	37
Limited Warranty.....	38

Licensing

“Made for iPod®” and “Made for iPhone®” mean that an electronics accessory has been designed to connect specifically to iPod® or iPhone® respectively, and has been certified by the developer to meet Apple performance standards. Apple is not responsible for the operation of this device or its compliance with safety and regulatory standards. Please note that the use of this accessory with iPod or iPhone may affect wireless performance. Apple is not responsible for the operation of the device or its compliance with safety and regulatory standards.

iPod and iPhone are trademarks of Apple Inc., registered in the U.S. and other countries.

Windows Media® and the windows logo are trademarks, or registered trademarks of Microsoft Corporation in the United States and/or other countries.

The Bluetooth® word mark and logos are owned by the Bluetooth SIG, Inc., and any use of such marks by Retro Manufacturing, LLC is under license. Other trademarks and trade names are those of their respective owners.

Made for iPod

(Correct function of earlier versions cannot be guaranteed.)

- iPod touch (4th generation): Ver. 5.1.1
- iPod touch (2nd generation): Ver. 4.2.1
- iPod touch (3rd generation): Ver. 5.1
- iPod nano (6th generation): Ver. 1.1
- iPod nano (5th generation): Ver. 1.0.2
- iPod nano (4th generation): Ver. 1.0.4
- iPod nano (3rd generation): Ver. 1.1.3
- iPod classic (160 GB) (Late 2009): Ver. 2.0.4
- iPod classic (120 GB): Ver. 2.0.1
- iPod classic (80 GB, 160 GB): Ver. 1.1.2

Made for iPhone

(Correct function of earlier versions cannot be guaranteed.)

- iPhone 4s: Ver. 5.1.1
- iPhone 4: Ver. 5.1.1
- iPhone 3GS: Ver. 5.1.1
- iPhone 3G: Ver. 4.2.1

For clarity in identifying your model of iPod, please see Apple's document "Identifying iPod models" at <http://support.apple.com/kb/HT1353>.

Welcome!

The Model Two combines classic styling with the advanced features you expect from a modern car stereo.

General Features

- The only classic car radio compatible with iPod and iPhone
- Built-in Bluetooth for hands-free calling and audio streaming
- Plays MP3 and WMA files via USB input
- Selectable 32,000 color LCD illumination with user presets
- AM/FM tuner with 30 presets and RDS
- Selectable USA/EU/Japan/AUS/RUS tuner frequencies
- Built-in amplifier (25 watts RMS/45 watts peak x 4 channels)
- 3 EQ presets plus user-controlled bass, treble, fader, mid-range and balance adjustment
- Authentic push-button styling
- InfiniMount shaft/bracket system for maximum installation flexibility
- Compatible with all RetroSound® vehicle specific bezel, plate and knob kits
- Inputs: 2 rear-mounted standard USB ports and 2 rear auxiliary inputs
- Outputs: 6-ch pre-amp outputs (front, rear, subwoofer)
- Separate power antenna and amp turn-on lead(s)
- 2 year parts and labor warranty

What's in the Box

The accessory items and hardware shown below are packaged with your Model Two radio.



Main Wire Harness
(Plug into back of radio)



Power/Speaker Wire Harnesses
(Plug both into Main Wire Harness)

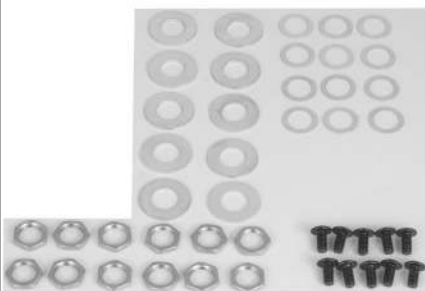

Shaft/Bracket Mounting Hardware



Plastic Washer Kit



Bluetooth
Microphone



Shaft Covers (2)



Removable InfiniMount
Shafts (2)



Mounting Backstrap
and Hardware



InfiniMount "L" Brackets (2)

Warnings and Precautions

This equipment has been tested and found to comply with the limits for a Class B device, pursuant to Part 15 of the FCC Rules. These limits are designed to provide reasonable protection against harmful interference in a residential installation. This equipment generates, uses and can radiate radio frequency energy, and, if not installed and used in accordance with instructions, may cause harmful interference with radio communications. However, there is no guarantee that radio interference will not occur in a particular installation. If this equipment does cause harmful interference to radio or television reception, which can be determined by turning the equipment off and on, the user is encouraged to consult the dealer or an experienced radio/TV technician for help. You are cautioned that any changes or modifications not expressly approved in this manual could void your authority to operate this equipment.

Observe these warnings and precautions when using this unit:

- **Carefully read this manual before using the unit.** If you encounter any problems that are not covered in this manual, please consult the dealer from which you purchased the unit or the dealer nearest you. You may also email us at support@retrosoundusa.com.
- **Do not turn the unit on if the temperature inside the car is very high.** Always allow the unit to cool down before usage.
- **The driver should neither watch the display nor operate the system while driving.** Watching the display or operating the system will distract the driver from driving safely and can cause accidents. Always stop the vehicle in a safe location and use the parking brake before watching the display or operating the system.
- **Use the proper power supply.** This product is designed for operation with a negative ground 12V DC battery system. Never operate this product with other battery systems, especially a 18/24V DC battery or positive ground system.
- **Do not disassemble or modify the unit.** Do not disassemble, modify the unit or attempt to repair the product yourself. If the product needs to be repaired, consult your dealer or Retro Manufacturing directly.
- **Do not use the unit when it is out of order.** If the unit is out of order (no power, no sound) or in an abnormal state (has foreign objects in it, is exposed to water, is smoking, or smells), turn it off immediately and consult your dealer.

- **Refer fuse replacement to qualified service personnel.** When the fuse blows out, eliminate the cause and have it replaced with the fuse prescribed for this unit by a qualified service technician. Incorrect replacement of the fuse may lead to smoke, fire, and damage to the product.
- **If the unit does not turn on, check the connections first.** Then check whether the fuse in your vehicle's fuse box is blown and check the fuse at the unit's wiring harness.

Observe these warnings and precautions during installation:

- **Do not expose the unit to direct sunlight or excessive heat.** Excessive heat will raise the interior temperature of the unit, which may damage the unit.
- **Do not use the product where it is exposed to water, moisture, or dust.** Exposure of the unit to water, moisture, or dust may lead to smoke, fire, or other damage to the unit and void your warranty. Make sure that the unit does not get wet in car washes or on rainy days.
- **Refer wiring and installation to qualified service personnel.** Installation of this unit requires special skills and experience. For maximum safety, have it installed by your dealer. Retro Manufacturing is not liable for any problems resulting from your installation of the unit. Please be sure to follow our instructions carefully before attempting installation.
- **Follow the instructions to install and wire the product.** Not following the instructions to properly install and wire the product could damage the unit or cause an accident or fire.
- **Disconnect the lead from the negative (-) battery terminal before installation.** Wiring and installation with the negative (-) battery terminal connected may cause electrical shock and injury due to a short circuit. Some cars equipped with an electrical safety system have specific procedures for battery terminal disconnection. FAILURE TO FOLLOW THIS PROCEDURE MAY LEAD TO THE UNINTENDED ACTIVATION OF THE ELECTRICAL SAFETY SYSTEM RESULTING IN DAMAGE TO THE VEHICLE AND PERSONAL INJURY OR DEATH.
- **Take care not to damage the leads.** When wiring, take care not to damage the leads. Prevent them from getting caught in the vehicle chassis, or from being damaged by screws or moving parts, such as seat rails. Do not scratch, pull, bend or twist the leads. Do not run them near heat sources or place heavy objects on them. If leads must be routed around sharp metal edges, protect the leads by winding them with vinyl tape or similar protection.

- **Use the designated parts and tools for installation.** Use the supplied or designated parts and appropriate tools to install the product. The use of parts other than those supplied or designated may result in internal damage to the unit. Faulty installation may lead to an accident, malfunction or fire.
- **Do not use safety-related vehicle components** Be careful not to wire or affix this product to the following parts of the vehicle: fuel tank, brake, suspension, steering wheel, pedals, airbag, etc.
- **In the case of installation to an airbag-equipped car, confirm warnings and cautions of the vehicle manufacturer before installation.**
- **Check for piping, gasoline tank, electric wiring, and other items before installing the product.** If you need to open a hole in the vehicle chassis to attach or wire the product, first check where the wire harness, gasoline tank, and electric wiring are located. Then open the hole from outside if possible.
- **Never install the product in a location where it interferes with your field of vision.**
- **Never splice into the power cord to supply other equipment with power.**
- **After installation and wiring, you should check the normal operation of other electrical equipment.** The continuation of their use in abnormal conditions may cause fire, electrical shock or a traffic accident.
- **Make sure the leads do not interfere with driving or getting in and out of the vehicle.**
- **Insulate all exposed wires to prevent short circuiting.**
- **Do not operate the unit for a prolonged period with the engine turned off.** Operating the audio system for a long period of time with the engine turned off will drain the battery.

Installation Warnings



To ensure proper operation of this RetroSound product, please read these instructions carefully before installing and using this equipment.

This owner's manual does not cover all possible installation scenarios. If you feel you can't install this product yourself, please take it to a local car audio professional, or contact us at support@retrosoundusa.com or call 909-364-1372 | 888-325-1555.



IMPORTANT! PLEASE NOTE THAT THIS UNIT REQUIRES +12V TO BOTH THE RED & YELLOW WIRES, OTHERWISE THE UNIT WILL NOT OPERATE. CONTACT US IF YOU HAVE QUESTIONS.



Disconnect the negative (-) battery cable before beginning installation. Verify the battery ground by checking that one wire is connected to the starter mounting bolt or engine block and another to the vehicle chassis using at least #8 gauge wire. Make sure the alternator connections are secure and free from corrosion, rust or dirt.



WARNING! To prevent damage to the unit, do not connect the power connector until you have completed the wiring process. This is a 12 volt negative-ground ONLY radio. If you have a positive ground system, or a 6-volt system, you need to either convert to 12 volts or purchase a separate inverter that would step up the voltage to 12 volts. Please note that the inverter needs to be rated at 8 amps or higher in order for the Model Two to operate properly.

Installation Instructions

NOTE: Getting the unit to fit perfectly into your dash is probably the most difficult portion of the install. Patience and persistence is the key. If you still have problems, please contact us at support@retrosoundusa.com or 909-364-1372.

The InfiniMount system offers nearly unlimited installation options to accommodate your fit needs.

To begin, locate the removable InfiniMount shaft system and the InfiniMount "L" brackets, as well as two each large and small washers (see "What's in the Box" on page 4). For more advanced installations, please visit our website: retrosoundusa.com or email support@retrosoundusa.com.

STEP 1: Install InfiniMount Brackets

Attach each InfiniMount bracket using the supplied screws. Before tightening, adjust the brackets forward or backward, or rotate to achieve the perfect fit. Complete the assembly with 2 or 4 screws tightened on either side.



Figure 1 - Attach InfiniMount Brackets

NOTE: You can move our brackets forward or backward and move them in any direction. You can even cut, trim or bend the bracket or create your own bracket for a more challenging installation. For more advanced installations, please visit our website: www.retrosoundusa.com or email support@retrosoundusa.com.

STEP 2: Mount Shafts to Brackets

1. To match the InfiniMount shaft and bracket system to the proper shaft width of your vehicle, first measure the distance between your existing shaft holes from center to center.
2. Mount a shaft system to each bracket using the supplied shaft nuts, metal and plastic washers.
3. Finger tighten to prepare for the final installation (see Figure 2).



Use supplied washers and nuts to place shafts onto brackets. **Important: DO NOT overtighten.**



Figure 2 - Mount Shaft to Bracket

4. Once sure of the proper width, tighten prior to final installation. Be sure to plug the shafts into each side of the main unit to activate the shaft-control functions (see Figure 3). **NOTE:** Each of the shafts can operate on either side of the radio and are not left/right dependant.



Figure 3 - Insert Shaft Plugs

NOTE: *Modifying or cutting the radio's brackets will not void your warranty. The system is designed to accommodate any installation scenario.*

STEP 3: Complete Wiring Connections

See "Wiring Instructions" on page 13.

STEP 4: Adjust to Fit Your Vehicle Specific Kit

One of the most frequent questions we get is "How can your radio fit my car?". The Model Two radio is a universal solution (one chassis for most vehicles) and its control face is a fixed size (3.5" W x 1.5" H). Most American cars fit the radio and the bezel from behind the dash. The bezel fits around the Model Two control face to fill the original factory opening.

The Model Two control face is NOT referred to as a faceplate. A faceplate is a piece that overlays or covers the top or front of the dash. A faceplate is used in most European or Japanese cars, and can also be used on a modified dash to disguise any blemishes or poorly made modifications.

Locate the appropriate bezel or faceplate and perform the following steps to mount the radio behind the dash opening:

FACEPLATE: Use the supplied nuts and washers to align the faceplate onto the shaft. DO NOT overtighten. Once the shafts are lined up to the shaft openings on your vehicle-specific faceplate, use a nut and washer to hold the faceplate in place on the shafts. Adjust the nut height so that the faceplate aligns flush with your dash and the radio's control face. See "Figure 4 - Install Vehicle Specific Faceplate".

BEZEL: Place the bezel on the face of the radio and install through the back opening of your dash.

NOTE: With the faceplate pictured below, the area around the radio face (chrome or black) mounts on top of the dash.



Nuts/washers installed between L bracket and faceplate



Figure 4 - Install Vehicle Specific Faceplate

STEP 5: Install Knobs

Once your radio is installed, follow the steps below to ensure a proper knob fit.

1. The included shaft covers may be used to cover up excess shaft metal during your installation. They can be cut to any length to conceal the shaft and make the install look more professional. See Figure 5 for an example.
2. Slide the rear knob over the shaft, rotating it into the correct position, and push it into place. See Figure 6.
3. Mount the front knob. See figure 7 and 8.



Figure 5 - Shaft Cover Installed (Note: this is an optional item to install)



Figure 6 - Install Rear Knob



Figure 7 - Install Front Knob



Figure 8 - Final Result

Wiring Instructions

PLEASE NOTE THAT THIS UNIT REQUIRES +12V TO BOTH THE RED AND YELLOW WIRES, OTHERWISE THE UNIT WILL NOT OPERATE.

CONTACT US IF YOU HAVE QUESTIONS.

support@retrosoundusa.com or 909-364-1372

Wiring Diagram (Figure 9)

Locate the three wire harnesses: Main Wire Harness, Power Wire Harness and Speaker Wire Harness (see "What's in the Box" on page 4). First connect the Main Wire Harness to the back of the radio. Then connect both the Power and Speaker Wire harnesses to the black female plug of the Main Wire Harness.

After doing this, connect the bare wire ends of your power and speaker wires to the appropriate power and speaker locations in your vehicle. (see Figure 9, "Wiring Diagram" on page 14) Please contact us if you have questions or have your radio installed by a professional if this part of the install is too difficult.

Installation Notes

- To prevent damage to the unit, do not connect the power connector until you have completed the wiring process.
- This is a 12 volt negative-ground ONLY radio. If you have a positive ground, or a 6-volt system, you need to either convert to 12 volts or purchase a separate inverter that would step up the voltage to 12 volts.
- Please note that the inverter must be rated at 8 amps or higher in order for the radio to operate properly.

Rear AUX Inputs

Two rear auxiliary inputs allow you to listen to any portable device with standard headphone outputs. An example of an external source would be a portable CD player, mini disc player, portable cassette recorder, iPod or MP3 player. Select an auxiliary input mode by turning the left rear knob clockwise until you see AUX IN 1 or AUX IN 2 on the Model Two's screen.

USB Extension Cable

Two USB connector cables are located at the rear of the Model Two radio. During installation, you must route the cable(s) to a convenient and accessible location for plugging in USB devices. If the cable(s) provided are not long enough (40 inches), you may plug in optional USB extensions during installation.

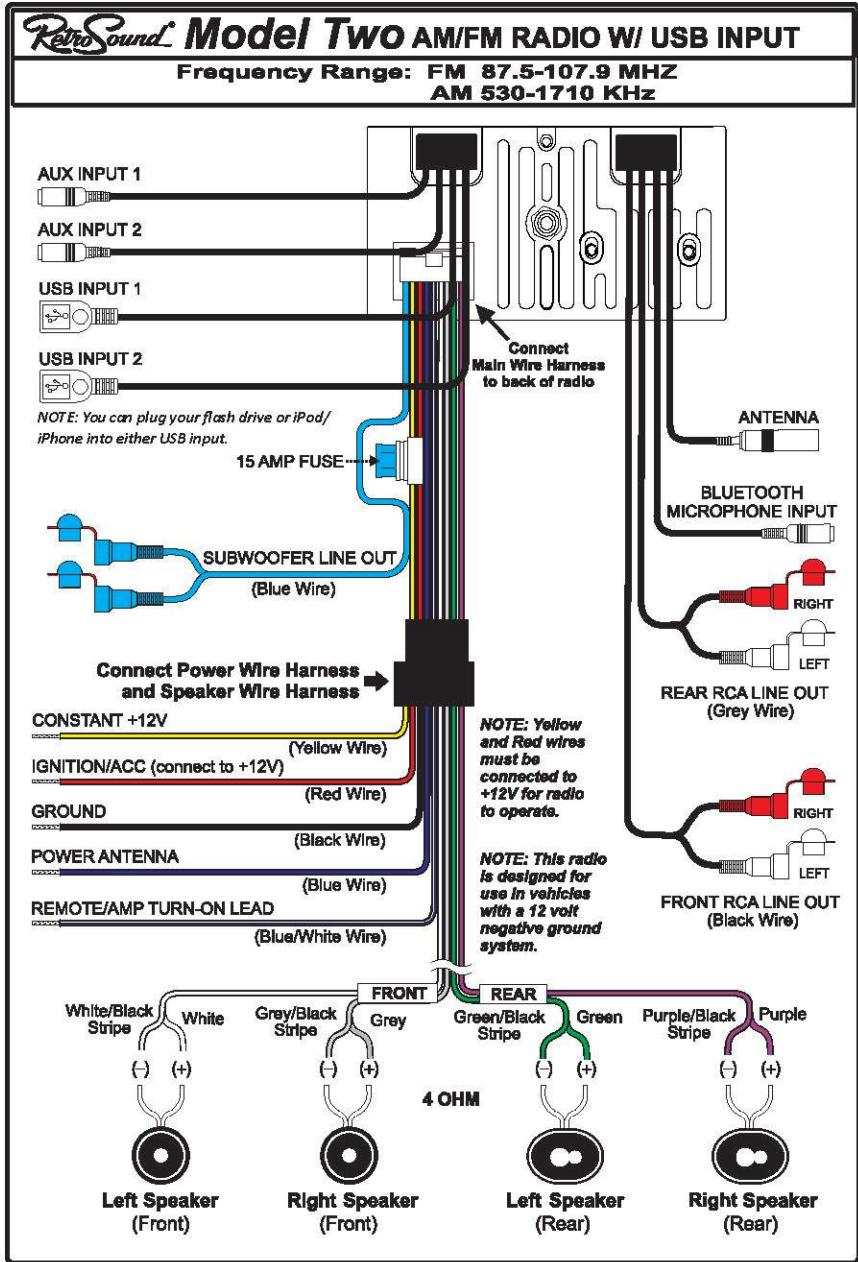

NOTE: Maximum operational distance of a USB cable is 16 feet. For optimum data transfer, we recommend no more than 12 feet of total cable length.

Figure 9 - Wiring Diagram

Using Your Radio (Basic Operation)

Front Panel Controls

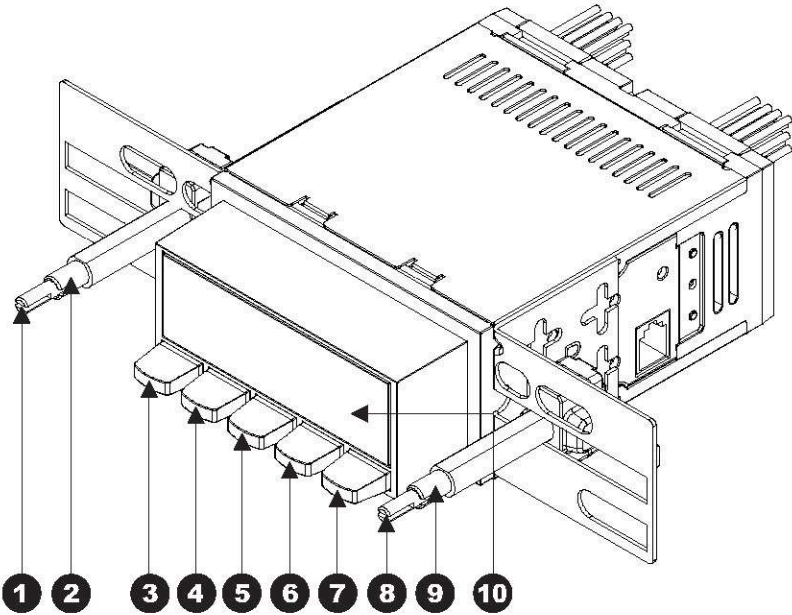
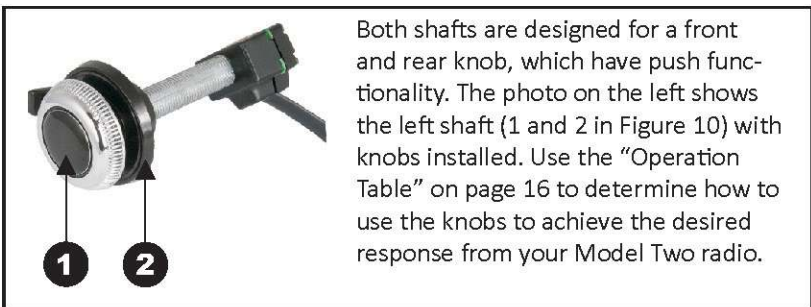

Figure 10 - Front Panel Controls



Both shafts are designed for a front and rear knob, which have push functionality. The photo on the left shows the left shaft (1 and 2 in Figure 10) with knobs installed. Use the "Operation Table" on page 16 to determine how to use the knobs to achieve the desired response from your Model Two radio.

Figure 11 - Shaft with Knobs

Operation Table

Function	#	Radio Mode	USB Mode
Power On/Off	1	Press the left front knob to turn the unit on. Look for RETROSOUND on power up. Press and <i>hold</i> the left front knob for 3 seconds to turn the unit off. The LCD display will show 50000000 for your confirmation.	
Volume	1	Turn the left front knob to adjust the volume attenuation between 0 - 46 (Min/Max). 17 is the default turn-on volume level.	
Audio Adjust	1	Press the left front knob to activate the SEL (Select) function. Press repeatedly to cycle through the DSP (Digital Signal Processing) EQ, Bass, Mid, Treble, Balance, Fader, XBAS, Subwoofer and Subwoofer specific adjustments (when SUB ON is selected). Turn the left front knob to select a value. See "Adjusting Sound Properties" on page 20 for detailed instructions.	
Mode	2	Turn the left rear knob clockwise to select from an available listening source: RADIO, USB-1, USB-2, AUX-1, AUX-2, BT AUDIO. Two sets of AUX inputs are located at the rear of the radio. To utilize these inputs, AUX cables must be routed to an accessible area during installation. See "Wiring Instructions" on page 13. NOTE: The USB option will not appear unless media is plugged into the USB connector.	
Clock On	2	Turn the left rear knob counter-clockwise to activate the clock on-screen feature.	Turn the left rear knob counter-clockwise to toggle and view artist, album, title information, clock.
View Song Info/Clock			
Preset 1 Recall/Store	3	Press to select the #1 radio preset. Press and <i>hold</i> to store preset 1 into memory.	Press to play/pause file playback.
Play/Pause			

Function	#	Radio Mode	USB Mode
Preset 2 Recall/Store	4	Press to select the #2 radio preset. Press and <i>hold</i> to store preset 2 into memory.	Press to play 10 seconds of each track on the flash drive. Press again to cancel the preview scan function. The song name appears as it plays. INT ◻◻ appears on the screen during intro scan mode.
Preview Scan			
Preset 3 Recall/Store	5	Press to select the #3 radio preset. Press and <i>hold</i> to store preset 3 into memory.	Press to randomly play all digital tracks on your flash drive, regardless of the folder selected. RDM ◻◻ appears on the screen during random mode.
Random			
Preset 4 Recall/Store	6	Press to select the #4 radio preset. Press and <i>hold</i> to store preset 4 into memory.	Press to move UP through folders on your drive. The first file in the selected folder will play. The screen will display DIR ◻◻1, DIR ◻◻2, etc.
Select Folder			
Preset 5 Recall/Store	7	Press to select the #5 radio preset. Press and <i>hold</i> to store preset 5 into memory.	Press to move DOWN through folders on your drive. The first file in the selected folder will play. The screen will display DIR ◻◻1, DIR ◻◻2, etc.
Select Folder			
Next/Previous	8	Turn the right front knob to tune to the next or previous AM/FM frequency. Note: When the radio is tuned into a strong station (in FM only), the FM indicator will show on the upper right side of the LCD display (2 oval circles). This indicator will only light up in FM mode and ONLY when a strong station is selected.	Turn the right front knob to change to the next/previous track. <i>This function also applies to Bluetooth audio mode.</i>

Function	#	Radio Mode	USB Mode
System Menu	8	<p>Press and <i>hold</i> the right front knob for 3 seconds to access the sub-menu system where you can adjust: Auto/Manual tuning, RDS, Clock or Frequency Priority, Beep ON/OFF, AREA USA/EU/Japan/AUS/RUS tuning, Stereo/Mono, Local/DX (distant) tuning, Vol Adjust/Vol Last and volume default level. Toggle the selection by turning the right front knob and pressing the right front knob to go to the next mode. See "Sub-Menu System" on page 24 for detailed instructions. <i>Press and release the right front knob to activate the MUTE function.</i></p>	
Preset 6 Recall/Store	9	Turn the right rear knob clockwise to select the #6 radio preset.	Turn and release the right rear knob clockwise to repeat the current track (RPT TRK) or repeat all tracks (RPT ALL). Turn and <i>hold, then release</i> the right rear knob clockwise to repeat the playback of songs in that folder (RPT FLD).
Repeat Play		Turn and <i>hold</i> the right rear knob clockwise to store preset 6 into memory.	
Band	9	Turn the right rear knob counter-clockwise to toggle through 5 radio bands (2 AM and 3 FM). Note: When tuning to a stereo FM station, a stereo indicator (two ovals) will show in the upper right side of the radio's LCD screen. If there is no stereo icon seen, the station is in mono.	Turn the right rear knob counter-clockwise once to select "FOLDER" search mode, turn the front right knob clockwise or counter-clockwise to select folders (directories) on the usb drive. Press and release the front right knob to select the folder, the first song in that directory will be heard. Turning the right rear knob counter-clockwise twice will select the "MUSIC" search mode. Turn the front right knob clockwise or counter-clockwise to select songs within that selected folder. Press and release the front right knob to select the desired song within the folder.
Track/Directory Search			

Function	#	Radio Mode	USB Mode
iPod/ iPhone Playlist/ Search	9		While in USB-1/USB-2 mode with an iPod/ iPhone connected to one of the USB inputs, turn the right rear knob counter-clockwise to select the PLAYLIST. Turn the front right knob clockwise to choose from PLAYLIST, ARTIST, ALBUM, GENRE, SONGS, COMPOSER, AUDIO BOOK or PODCAST. Press and release the front right knob to access one of the selected items, then turn clockwise to select items within the list. Press and release the front right knob again to listen to the selected item. To repeat the song or songs on the album, turn the right rear knob clockwise to select Repeat one or Repeat all.
LCD Display	10	Backlit LCD Display	

See “Bluetooth Instructions” on page 32 for specific instructions for using a connected Bluetooth device with the Model Two.

Adjusting Sound Properties

Adjusting the sound properties:

1. Press the left front knob, then release, to access the sound properties menu.
2. Repeatedly press and release the front left knob to scroll through the available menu options.
3. Turn the left front knob right or left to select a value for the chosen menu option.
4. Press and release the left front knob repeatedly to move to the next function desired, or do nothing and the menu will revert to the current source display.

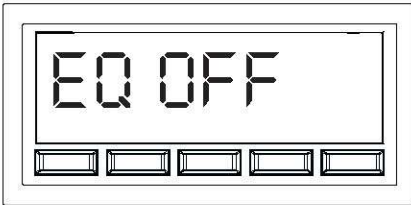

EQ OFF

When you first access the left front knob menu, EQ is set to OFF. Turn the left front knob right to view and select the 3 preset equalizer options.

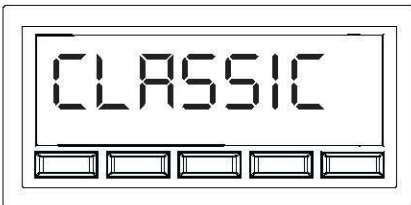

CLASSIC

The CLASSIC setting offers sonic adjustments that lend themselves to classical music.

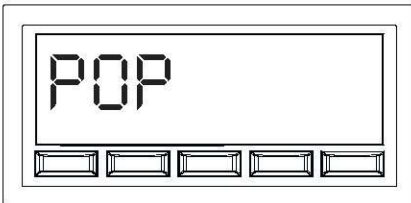

POP

The POP setting accentuates the bass and treble settings. This is suitable for bass heavy popular music.

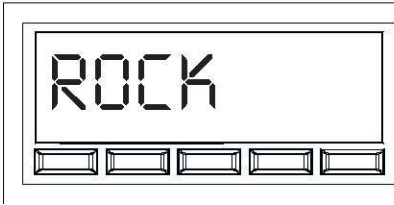

ROCK

The ROCK setting accentuates the treble settings. This is suitable for rock music.

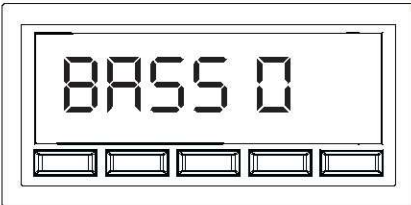

BASS

The bass adjustment function allows you to boost or cut the low frequencies from -7 to +7.

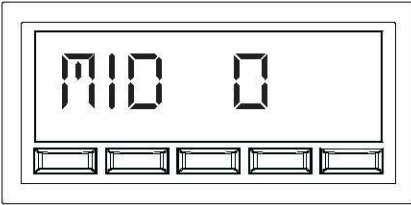

MID

The mid-range adjustment function allows you to adjust the middle frequencies -7 to +7.

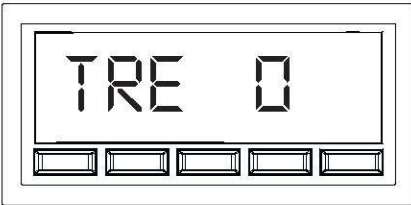

TREBLE

The treble adjustment function allows you to boost or cut the high frequencies from -7 to +7.

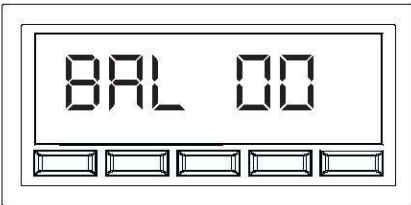

BALANCE

The balance adjustment function allows you to adjust or pan the stereo sound from the left or right. This is helpful to compensate for the position of the driver in relation to the speakers. Adjustment range is 0-12 between the left and right speakers.

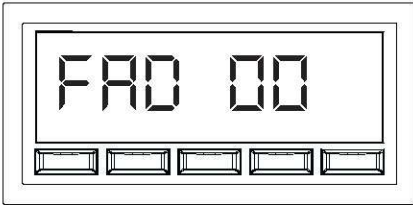

FADER

The fader control allows you to fade the sound from the front pair of speakers to the rear pair of speakers. Adjustment range is 0-12 between front and rear speakers.

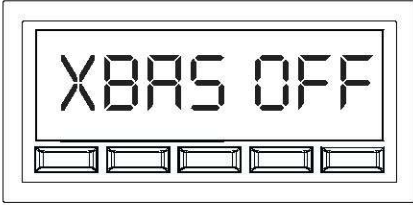

XBAS

This function boosts bass and treble at low listening volume and should be turned off at higher volumes. You will know this function is active when you see "XBAS" on your display. Adjusting your Bass, Mid or Treble settings will override the XBAS function.

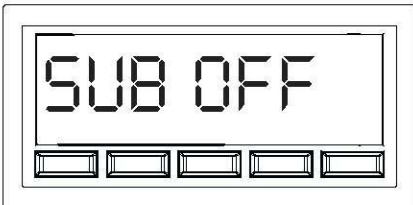

SUB ON/OFF

Turn the subwoofer RCA output ON to activate this feature.

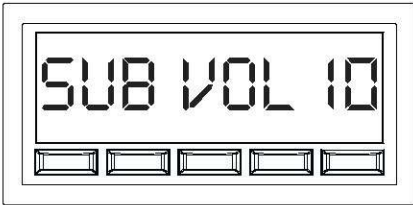

SUB VOL

When SUB ON is selected and a subwoofer is attached to the unit, use this function to increase or decrease the volume level of the subwoofer outputs from 0-12.

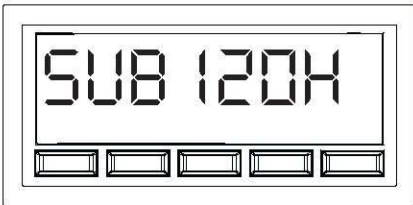

SUB

When SUB ON is selected and a subwoofer is attached to the unit, use this function to adjust the subwoofer crossover point to 80HZ, 120HZ or 160HZ.

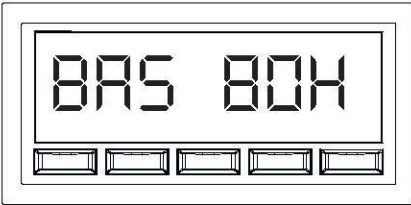

BAS

Use this function to make a more detailed boost or cut adjustment of bass (low) frequencies as follows: 60/80/100/200Hz. This is a very useful mode for making very specific tonal adjustments. When selecting one of these 60/80/100/200Hz points, any changes to the prior BAS menu settings on page 21 (-7 to +7) will boost or cut at the selected frequency setting chosen in this menu.

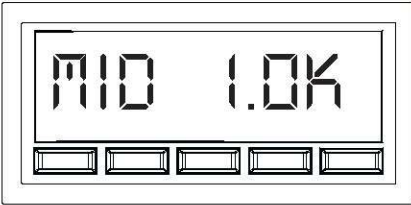

MID

Use this function to make a more detailed boost or cut adjustment of midrange (vocal) frequencies as follows: 0.5K/1.0K/1.5K/2.5KHz. Default setting is 1.0KHz. This is a very useful mode for making very specific tonal adjustments. When selecting one of these 0.5K/1.0K/1.5K/2.5KHz points, any changes to the prior MID menu settings on page 21 (-7 to +7) will boost or cut at the selected frequency setting chosen in this menu.

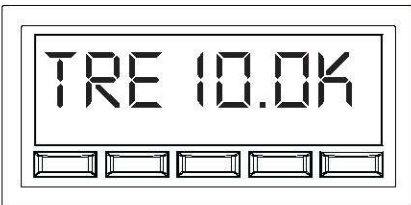

TRE

Use this function to make a detailed boost or cut adjustment of treble frequencies as follows: 10.0K/12.5K/15.0K/17.5KHz. Default setting is 10.0KHz. When selecting one of these 10.0K/12.5K/15.0K/17.5KHz points, any changes to the prior TRE menu settings on page 21 (-7 to +7) will boost or cut at the selected frequency setting chosen in this menu. This is a very useful mode for making very specific tonal adjustments.

Sub-Menu System (Right Knob)

Accessing the sub-menu system menu:

1. Press and *hold* the right front knob for 3 seconds, then release, to access the sub-menu system.
2. Repeatedly press and release the front right knob to scroll through the available menu options.
3. Turn the right front knob right or left to select a value for the chosen menu option.
4. Press and release the right front knob repeatedly to move to the next function desired, or do nothing and the menu will revert to the current source display.

Sub-Menu Options

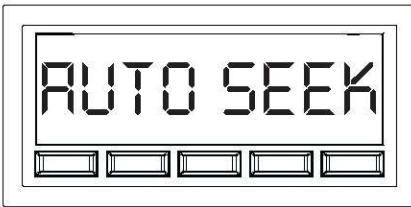

AUTO SEEK

This function allows you to select auto seek tuning or manual tuning when you turn the right front knob to the right or left when listening to the radio. The factory default setting is AUTO SEEK. Turn the right front knob clockwise or counter-clockwise to select manual or auto.



A STORE

This function will automatically fill presets with the strongest stations found for the current band. Turn the right front knob clockwise to activate this feature.

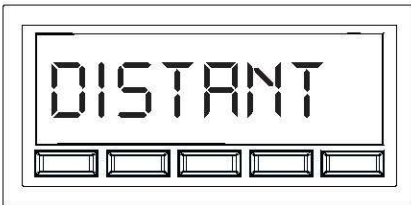

LOCAL/DISTANT

When listening to the FM tuner, you can access the LOCAL or DISTANT (default) option. Selecting between the local and distant settings can aid in listening to weak FM radio stations or compensate for stations that have too strong of a signal.

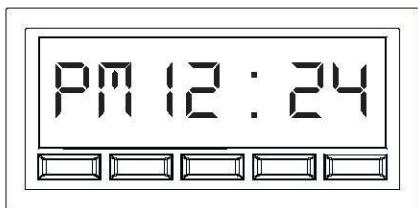

CLOCK

Choose the clock function to adjust the clock hours and minutes. Adjusting past 12 will toggle the AM/PM indication. Pressing the front right knob after adjusting the time will take you to the CLK 12/24 menu.

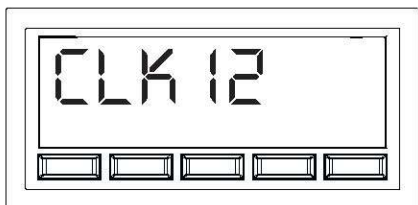

CLK 12/24

Adjust this function to choose between the 12 and 24 hour clock mode. The factory default setting is CLK 12.

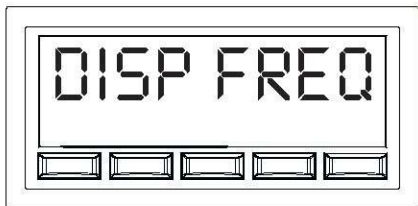

DISP FREQ/CLK

The unit default setting displays frequency on the screen. Select DISP CLK to show the clock as the priority screen view. Turn right front knob either clockwise or counter-clockwise to select DISP CLK or DISP FREQ.

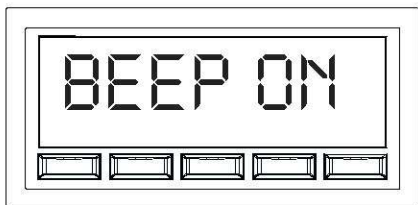

BEEP ON/OFF

This function controls the audible beep confirmation that sounds during radio operation. With the beep function displayed, turn the right front-knob to select BEEP ON or BEEP OFF.

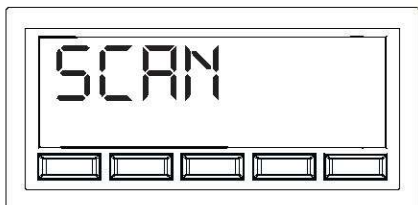

SCAN

Select the desired color preset. By default, the LCD lighting will alternate between all colors. Preset color options include WHITE, GREEN 1, GREEN 2, GREEN 3, ORANGE, RED, PINK, PURPLE 1, PURPLE 2, BLUE 1, BLUE 2, USER*, and AMBER.

**To customize your own display color, select "USER" in the preset color menu, then press and release the right front knob. Once in this mode, press and release the right front knob to toggle R, G or B (RED, GREEN or BLUE) modes (they will blink when selected). In each mode, you can change the color hue by rotating the right front knob from 00-32 in each mode to select the desired color. To move to the next RGB mode, press the right front knob, then make your color selection. Note: if you lower all RGB settings down to "00" the display will go black, you will need to reset the radio by disconnecting all power from the unit for 2 minutes. This will reset your radio to the factory defaults.*

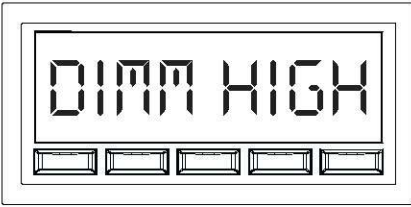
DIMMER

Use this menu option to switch the LCD brightness between high (DIMMER HIGH) and low (DIMMER LOW) Turn the right front knob clockwise or counter-clockwise to make your selection.

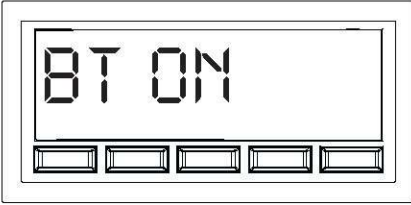
BT

Adjust this feature to turn the Bluetooth function ON/OFF. Turn the right front knob clockwise or counter-clockwise to make your selection.

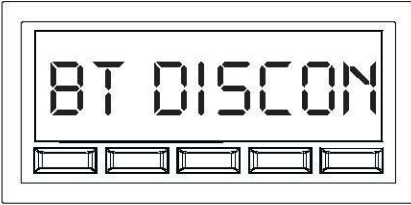
BT DISCON/CONNEX

Turn the right front knob clockwise to select "CONNEX" to enable the Bluetooth function and search for "RETROSOUND" in your phone's Bluetooth device list. Enter password (0000) if prompted. Turn counter-clockwise to select "DISCON" and disconnect a Bluetooth device.

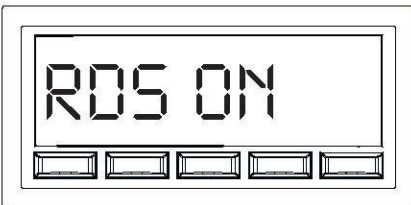

RDS ON/OFF

RDS stands for Radio Data System. This function allows you to turn off the RDS function if you do not want to see the RDS information. The factory default setting is RDS ON.

RDS tuners can automatically tune in stations according to the style of music (or talk) they broadcast. Some RDS tuners can even break in with traffic alerts or emergency broadcasts.

RDS enables your receiver to display text messages (usually call letters and format info) that many FM stations include on a subcarrier signal within their normal broadcast signal.

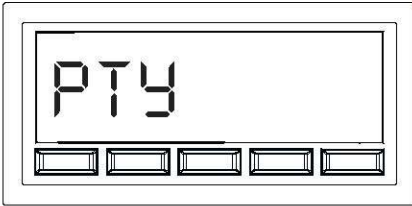
The RDS function is always active, and if the FM station you are listening to is broadcasting RDS information, the radio station call letters, song info, artist info and other messages will appear. **Please note that not all FM stations use RDS nor will all RDS functions work in the US.**



PROGRAM TYPE (PTY)

RDS has a function called PTY (Program Type). **Note: This mode works in AREA EUR only.** This coding of up to 31 pre-defined program types allow you to find similar programming by genre.

When using this function, you can select the desired station genre from the list below to find stations with the same programming genre in this area.

Once the program type has been selected, the tuner will search all available FM stations for a station broadcasting the selected program category.

To search for your desired Program Type:

1. **Make sure that the tuner is in "AREA EUR".** When you see PTY on-screen, press and release the left front knob, then turn the right front knob clockwise or counter-clockwise to select from the Program Type list.

2. Press and release the right front knob to select the desired Program Type.

3. Once the desired Program Type is selected, you will see PTY SEEK show on-screen, this indicates that the radio is searching the entire FM band for radio stations with the selected Program Type. After making the selection, the radio will find the strongest stations with the selected program type, if none are found, you will see NONE FOUND on-screen and the unit will revert back to the last radio station selected.

Program Type list (in order of appearance when selecting them).

NEWS, AFFAIRS, INFO, SPORT, EDUCATE, DRAMA, CULTURE, SCIENCE, VARIED, POP, ROCK, EASY, LIGHT, CLASSICS, OTHER, WEATHER, FINANCE, CHILDREN, SOCIAL, RELIGION, PHONE IN, TRAVEL, LEISURE, JAZZ, COUNTRY, NATION, OLDIES, FOLK, DOCUMENT, A-TEST, ALARM.

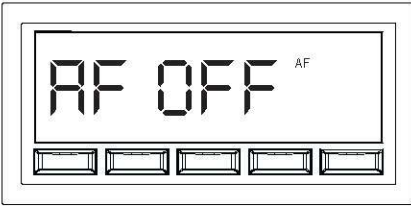

AF ON/OFF

When the RDS AF function is active (AF will blink on-screen), and the station supports this mode, the unit will search for the next strongest station when the one you're listening to gets weak (FM only).

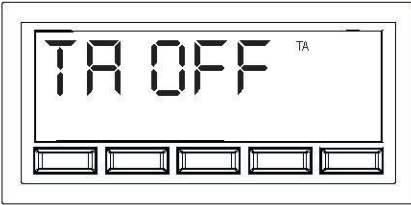

TA ON/OFF

Adjust to turn the Traffic Announcement (if supported by the station) function on/off. The RDS TA function allows FM stations to broadcast traffic announcements that scroll across the screen and will also broadcast audible traffic alerts to your radio. (TA will blink on-screen when activated)

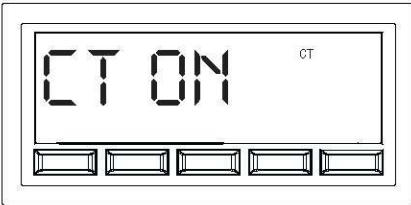

CT ON/OFF

If supported by the station, adjust to turn the CT (Clock Time) function on/off. This feature can synchronize the clock with the radio station's clock.

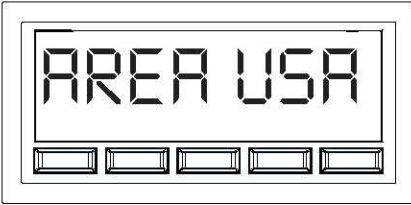

AREA (USA/EUR/AUS/JAP/RUS)

The Model Two radio has the capability to receive AM/FM broadcast frequencies in other countries. To modify the default setting, AREA USA (default), turn the right front knob.

To confirm the change, let the sub-menu revert to your tuner. You will see your selected mode: AREA USA, AREA EUR, AREA AUS, AREA JAP or AREA RUS show on-screen.

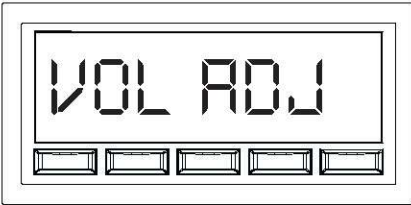

VOL ADJUST/LAST

Factory default for this menu option is VOL LAST, which maintains the last volume the radio was at when you turned it off. When you select VOL ADJ, you can set the default turn-on volume at any level (AD VAL 00-46), regardless of what the volume level was when you last turned off the unit.

USB Device Instructions

Attaching a USB Device

The USB 1 and USB 2 inputs are located at the rear of the Model Two radio. During installation, you may route the USB cable(s) to a convenient and accessible location for plugging in USB devices.

Once you've turned on the Model Two and connected your flash drive to the USB input, the radio will find your songs and automatically begin playing them from any mode.

The **USB**  icon appears on the LCD during USB playback.

To change songs, turn the right front knob to the right or left to access the next or previous song. Please note that the preset buttons on the front of the radio's control face will allow you to play/pause, listen to 10 seconds of each song (INT) or repeat the track you're listening to (RPT) or randomly select from all songs on the attached thumb/flash drive (RDM).

NOTE: The unit MUST be in USB mode for it to read the USB files on your flash/thumb drive. See "Operation Table" on page 16.

About MP3/WMA Files

MP3 (MPEG Audio Layer-3) and WMA (Windows Media Audio) is a format for compressed audio files. When the Model Two radio is in USB mode (USB 1 or USB 2), you can play MP3 and unprotected (no DRM) WMA files off the flash drive.

Common facts about these compressed-sound formats:

- High bit rate and high sampling frequencies are recommended for high sound quality.
- Selecting VBR (Variable Bit Rate) is not recommended because playing time is not displayed properly and there may be some audible skipping artifacts. The playback sound quality differs depending on the encoding circumstances. For details, refer to the user manual of your own encoding software.
- When adding MP3 files to your flash drive, it is recommended to set the bit rate to "128 kbps or more" and "fixed".
- When adding WMA files to your flash drive, it is recommended to set the bit rate to "64 kbps or more" and "fixed". Do not set the copy protect attribute on the WMA file or you will not be able to play the track.

Model Two Owner's Manual

- The Model Two will read only FAT or FAT32 formatted flash drives. This radio will NOT read NTFS formatted drives.
- The Model Two will read files placed in the root directory first before playing files in the folder structure of the drive. Please note that files are read in order of creation NOT alphabetically or numerically. Older files will get read first in a folder.

Caution! Except for private use, duplicating audio data (including MP3/WMA) or distributing, transferring or copying it, whether free or paid for without permission of the original copyright holder is strictly prohibited by the Copyright Act and international treaty.

Viewing MP3/WMA Song Information

When playing MP3/WMA files from the USB source, the Model Two allows you to view the track name, album, artist info (ID-3) information automatically from these files. Once the USB drive is inserted, the following info will scroll across the screen in the following order: F-DIR (folder directory), MP3 FILE (file name of song), ALBUM (name of album) ARTIST (name of artist), SONG (name of song).

NOTE: To access the clock when in USB mode, repeatedly turn the left rear knob counter-clockwise to activate the clock on screen feature. The clock will display until you turn the left rear knob counter-clockwise again or leave it alone and it will revert to viewing the ID-3 information on-screen.

USB Playback Mode

The preset buttons on the front of the radio's control face (1-5) will allow you to play/pause, listen to 10 seconds of each song (INT), repeat the track you're listening to (RPT), randomly select from all songs from a USB thumb/flash drive (RDM), and navigate folders. See "Operation Table" on page 16 for additional operating instructions for USB mode.

Bluetooth Instructions

Bluetooth Hands-Free and A2DP Streaming Operation

You can make or receive phone calls using a Bluetooth enabled phone connected to the Model Two, controlling basic functions via the radio interface. During a call, the radio music source will be muted and the call broadcast through your car speaker system. You can also listen to music stored on a A2DP enabled Bluetooth device.

Pairing a Bluetooth Device

When connecting a Bluetooth device for the first time, you must first pair the device with the unit.

For most devices, pairing only needs to be done once.

Please follow these steps:

1. Make sure the BT (Bluetooth) function is turned "ON" in the radio Sub-Menu. See "Sub-Menu System" on page 24.
2. Change the "BT DISCON" function to "BT CONNEX".
3. Ensure Bluetooth is enabled on the phone to be connected to the unit.
4. Search for a new Bluetooth device from the phone (this may take up to 30 seconds).
5. Select "RETROSOUND" from the Bluetooth device list.
6. Some devices may require you to enter a PIN. If prompted, enter "0000" for the PIN.
7. "PAIRING OK" will be displayed on the LCD display if pairing is successful. The paired device will then connect to the Model Two automatically.

On some phones, you may need to select "SET AS AUTHORIZED" or similar to ensure the Model Two will automatically pair on subsequent usage.

PAIRED NOTIFICATION DISPLAY: When the Bluetooth device is paired with the Model Two, the Bluetooth icon will appear on the LCD display. This should occur whenever you use the system while the paired device is in range.

Making a Call

1. Dial the desired number on the paired mobile phone.
2. Once dialing is in progress, "CALLING" will be displayed on the LCD.
3. When the call is in progress, "TALK" will be displayed on the LCD, along with the elapsed call time (TALK 00:00).

Receiving a Call

1. If a call comes in, audio playback from the current source will either be muted or paused (depending on the source) and "PHONE IN" will be shown on the display, along with the Caller ID, if it is enabled by the phone/carrier.
2. Turn the left rear knob counter-clockwise to accept the call.

Ending a Call

To end the call, turn the left rear knob counter-clockwise to end the call.

NOTE: Regarding placement of the included Bluetooth microphone, we suggest mounting the microphone on the sun visor, A-pillar or steering column inside the vehicle, closest to the driver. The microphone is very sensitive and you may speak at a normal volume when using hands-free operation.

Streaming music from your device

The Model Two radio is capable of wireless music playback using the built in Bluetooth technology. Once your device is paired with the radio, you may stream music by selecting your desired playback source on your device and starting the application (ex: Pandora, Slacker) or by selecting music stored on your device. Make sure that the Model Two radio is in BT AUDIO mode (See "Operation Table" on Page 16) to check how to switch to this source mode. Please note that Bluetooth wireless technology has a maximum range of 30 feet from the radio.

Troubleshooting

Problem	Possible Cause	Action to Solve Problem
Radio will not turn on (no lights, no sound)	12 volt Batt+ wire not connected or incorrect voltage	Check all connections for proper voltage with a volt meter. Voltage range: 12-15 volts
	+12 volt accessory wire not connected or incorrect voltage	Check +12 volt accessory wire connection
	Ground wire not connected	Check ground connection
	Fuse on Batt+ is blown	Replace blown fuse
No sound heard from unit but unit lights up	Volume turned all the way down	Increase radio volume
	Internal amp in protection mode	Check speaker leads for any grounded or shorted wires
	Make sure the unit is in the desired source mode (AUX,BT Audio, etc)	Check to make sure that unit is in desired source mode
Unit blows fuses	Possible short in wiring	Incorrect fuse used, make sure only fuses with correct 15 amp ratings are used / Check all wiring connections for possible short
	Battery hooked up backwards	Make sure battery is properly connected
USB ERR	Invalid media/device type	Please review page 30 to learn which formats and devices are acceptable for playback in this unit

System Reset

To restore/reset the unit to factory defaults, remove all power from the unit, wait 2 minutes and then reconnect power.

Frequently Asked Questions

Do your radios work on 6 volt systems or on positive ground systems?

No. Our radios are 12 volt, negative ground only. After-market converters and inverters are available, but must have at least 8 amps of continuous output.

I have your radio and am having problems getting it to turn on.

RetroSound radios require 12 volts to both power leads. The red lead (+12V accessory) goes to a switched power source, and the yellow to constant 12 volt (+12 V) power source. Using a volt meter, check the voltage when the key is turned from "off" to "on". If there is a significant drop in the voltage, the circuit to which you have the yellow lead attached cannot handle the additional draw of the radio. You will need to find another circuit that can handle the additional draw of the radio, or you will need to go directly to the battery.

What speaker wire do you recommend I use?

We recommend using 16 or 18 gauge wire for the speakers. If it is a longer run, we recommend using 12 gauge only.

I have all 4 speakers connected to your radio and the display is lit up like it is working, but there's no sound coming out.

This usually indicates one of two things:

1. Speaker wires touching each other or the vehicle chassis at some point. Check each speaker lead from radio to speaker.
2. Speaker impedance below 4 Ohms. Older speakers are usually not compatible with modern electronics.

My car originally came with a switch to control my automatic antenna. Can I use the RetroSound radio's remote antenna wire to do this?

No you cannot, your factory antenna is known as "semi-automatic." It requires a switch to either extend or retract the antenna. You must retain this switch to control your antenna; the RetroSound radio's power antenna wire is for more modern "fully-automatic" antennas not requiring a separate switch.

The sound output is all mid-range, with very little bass and a strangled-sounding upper range. What is wrong?

One of your speaker wires is connected backwards. This is called being "out of phase." Check to make sure positive is wired to positive and negative to negative on all your speakers.

Will cutting or bending the Model Two's InfiniMount brackets void the warranty or harm the unit?

No. The RetroSound® patented InfiniMount bracket system has been designed specifically to be bent, cut and modified to simplify radio installation. Modification to the radio's brackets is actually encouraged to ensure proper fit.

For questions about modifying the bracket system, please feel free to contact us at support@retrosoundusa.com or 909-364-1372.

I have my radio with an amp connected, but hear a whining/buzzing sound through the speakers when I step on the accelerator.

If you have an external amplifier installed and experience a high-pitched noise that varies with the engine's RPM, there are many possible solutions:

1. Make sure the amplifier's gain controls are not turned all the way up. Amplifiers amplify everything, including noise.
2. Make sure to run the amplifier's low level input cables (RCA's) separately from the amplifier's power wire.
3. Try grounding the amplifier near where it is installed.
4. A low level (RCA) noise filter, known as a "ground loop isolator," is often effective at removing engine or alternator noise.
5. Try a filter on the amplifier's 12 volt power lead. Make sure to use a filter that includes a ground wire.
6. On rare occasions, noise can be introduced through the antenna lead. If disconnecting the antenna makes the noise go away, you need to replace or repair the antenna plug where it goes into the radio.

When I plug in my flash drive, the screen says "USB ERR" and it won't play the files I placed on the drive.

1. Make sure the files on the drive are .mp3 or unprotected .wma (Windows Media Audio) files. iTunes files are .m4a format and need to be converted to .mp3 format, which can easily be done using iTunes.
2. Verify the capacity of the flash drive. The Model Two will play 1 gig up to 32 gig size flash drives.
3. Make sure the flash drive is not NTFS formatted. Always use the FAT32 format (most drives are formatted with FAT32 from the factory). Be sure to do a full format rather than a quick format, and check that none of the files or folders have names longer than 64 characters. It is very important that none of the audio files have DRM. Use only MP3 files or unprotected Windows Media format files.

specifications

FM

Tuning Range (EU and US Tuning Capable) with RDS	87.5-107.9MHz
Antenna Terminal	External Antenna Connector
Usable Sensitivity	12.5 dBf
Selectivity	75 dB @ 400kHz
Signal to Noise Ratio.....	62 dB (Stereo), 67 dB (Mono)
Harmonic Distortion @ 1 kHz	0.8% (stereo), 0.5% (monaural)
Separation	32 dB @ 1kHz
Frequency Response	30-16,000 Hz

AM (EU and US Tuning Capable)

Tuning Range	530-1710 kHz
Antenna Terminal	External Antenna Connector

General

Dimensions (Radio Face Only)	3.5"W x 1.5" H x 1.05" D
Dimensions (Radio Body)	3.96"W x 1.98"H x 4.30"D
Power Requirements	10.5-14.4V
Current Consumption (during operation).....	Max. 15A
Current Consumption (car off)	<3.5 mA
Output Power (@ 14.4V @ 4 ohm @ 1% THD)	25x4w RMS 45x4 Max Power
Output Impedance	4-8ohm
Low Level Output (4 Channels).....	2.85V
AUX 1 Input (Aux cable length, 8")	≥300 mV / 6 kΩ
AUX 2 Input (Aux cable length, 8")	≥300 mV / 6 kΩ
USB 1 Input (USB cable length, 40")	5V (USB Female Input)
USB 2 Input (USB cable length, 40")	5V (USB Female Input)

NOTE: All specifications are subject to change without notice.

Limited Warranty

If your product does not work properly because of defects in materials and workmanship RetroSound, a division of Retro Manufacturing, LLC (collectively referred to as "the warrantor") will, for the length of the period indicated in the chart below, which starts with the date of original purchase ("warranty period"), at its option either (a) repair your product with new or refurbished parts, or (b) replace it with a new or refurbished product. The decision to repair or replace will be made by the warrantor.

CATEGORIES	PARTS	LABOR
Model Two Radio	Two (2) Years	Two (2) Years

During the "Labor" warranty period, there will be no charge for labor. During the "Parts" warranty period, there will be no charge for parts. You must carry in or mail in your product prepaid during the warranty period. If batteries are included, they are not warranted. This warranty only applies to products purchased and serviced in the United States, Alaska, Hawaii or Puerto Rico. This warranty is extended only to the original purchaser of a new product which was not sold "as is". A purchase receipt or other proof of the original purchase date is required for warranty service.

To handle a warranty issue, contact us at support@retrosoundusa.com or 909-364-1372 and get a Return Authorization number. All returns and warranty issues must receive a Return Authorization (RA) number. Any product received without a RA number will be refused.

Retro Manufacturing, LLC

Phone: 909-364-1372

Fax: 909-364-8670

LIMITED WARRANTY-LIMITS AND EXCLUSIONS

This warranty ONLY COVERS failures due to defects in materials and workmanship, and DOES NOT COVER normal wear and tear or cosmetic damage. The warranty ALSO DOES NOT COVER damages which occurred during shipment, failures which are caused by products not supplied by the warrantor, failures which result from accident, misuse, abuse, neglect, bug infestation, mishandling, misapplication, alteration, faulty installation, set-up adjustment, maladjustment of consumer control, improper maintenance, improper antenna, inadequate signal reception or pickup, power line surge, improper voltage supply, lightning, modification, commercial use (such as use in hotels, offices, restaurants, or other business uses) or rental use of the product, or service by anyone other than the technician from the factory service center or other authorized service centers, or damage that is attributable to acts of God.

THERE ARE NO EXPRESS WARRANTIES EXCEPT AS LISTED UNDER "LIMITED WARRANTY". THE WARRANTOR IS NOT LIABLE FOR INCIDENTAL OR CONSEQUENTIAL DAMAGES RESULTING FROM THE USE OF THIS PRODUCT, OR ARISING OUT OF ANY BREACH OF THIS WARRANTY. (As examples, this excludes damages for lost time, cost of having someone remove or re-install an installed unit if applicable, travel to and from the sevice, and loss of media, data or other memory contents. The items listed are not exclusive, but are for illustration only.) ALL EXPRESS AND IMPLIED WARRANTIES, INCLUDING THE WARRANTY OF MERCHANTABILITY, ARE LIMITED TO THE PERIOD OF THE LIMITED WARRANTY.

Some states do not allow the exclusion or limitation of incidental or consequential damages, or limitations on how long an implied warranty lasts, so the exclusions may not apply to you. This warranty gives you specific legal rights and you may also have other rights which vary from state to state. If a problem with this product develops during or after the warranty period, you may contact your dealer or service center.

RetroSound[®]

Modern Sound for your Classic

Retro Manufacturing
5785 Waco Street
Chino, California 91710
Phone: 909-364-1372
Fax: 909-364-8670
www.retrosoundusa.com